

## Laser Distance Finder

Extech DT500



## Introduction

Congratulations on your purchase of the Extech Model DT500 Laser Distance Finder. This meter measures Distance up to 70m (230') and calculates Area and Volume. In addition, the DT500 includes a laser pointer for accurate targeting. This meter is shipped fully tested and calibrated and, with proper use, will provide years of reliable service.

## Safety Instructions

This meter has been designed for safe use, but must be operated with caution.

**WARNING: Do not directly view or direct the laser pointer at an eye.** Low power visible lasers do not normally present a hazard, but may present some potential for hazard if viewed directly for extended periods of time.

### Laser classification (Class 2)

The DT500 produces a visible Class 2 laser beam from the top of the instrument. Do not stare into the laser beam or direct the beam toward anyone's eyes. Eye protection is normally an automatic response ('blink reflex', for example).

**Warning:** Do not look directly into the laser beam using optical aids such as binoculars or telescopes. This can create a hazard.

### Permitted Uses

- Measure Distances
- Compute Area and Volume

### Prohibited Uses

- Exceeding the specified measurement limits
- Compromising or deactivating the safety systems built into the meter
- Removal of hazard or explanatory labels affixed to the meter
- Modifying or converting the instrument
- Using third party accessories
- Operation on scaffolding or ladders without proper safety precautions
- Measuring near machines that are operating or near parts of machine installations that are unprotected
- Aiming the meter into the sunlight
- Outdoor measurements or measurements on roads, near construction sites, etc. without adequate safeguards



# Descriptions

---

## Front Panel

1. LCD display area
2. Keypad
3. Level
4. Measure button
5. Laser Pointer
6. Sensor Testing Beam

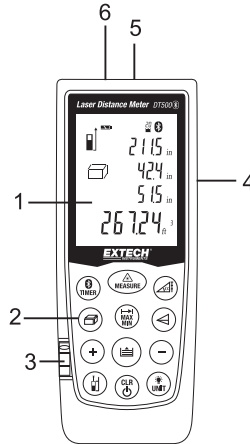

## Rear Panel

1. Laser warning label
2. Battery compartment latch
3. Battery compartment
4. Positioning bracket
5. Tripod mount

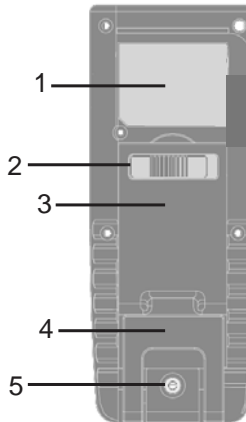

## Display Description

1. Laser Continuous mode is active
2. Reference level - front
3. Reference level - rear
4. Reference level - tripod
5. Reference level – end piece
6. Area/Volume measurement functions
  - Single Pythagorean measurement
  - Double Pythagorean measurement
  - Double Pythagorean (Partial Height)
  - Tilt measurement
8. Stake-out function
9. Battery status
10. Single distance measurement
11. Continuous measurement and MAX/MIN
12. Instrument Error message
13. Memory
14. Bluetooth icon
15. Time
16. Tilt
17. Display Line 1
18. Display Line 2
19. Display Line 3
20. Display Line 4 (Summary line)

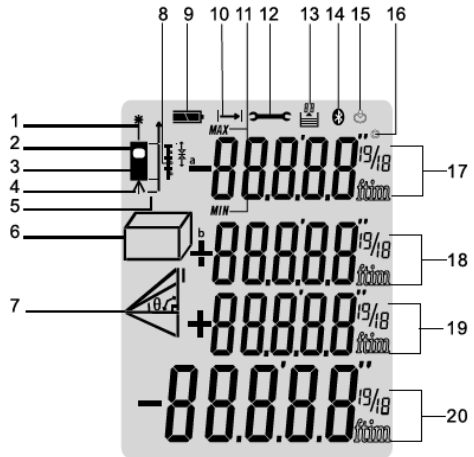

## Keypad Description



Bluetooth/Timer Button



Power ON / Measure Button /Laser on-off



Tilt/Stake-out Button



Area-Volume Button



MAX-MIN Single/Continuous Measurement Button



Indirect Measurement Button



Add Button



Memory Store-Recall Button



Subtract button



Measurement Reference Button



CLEAR / Power OFF Button



Backlight / Unit Button





Note: A measurement button is also located on the right side of the instrument

# Operating Instructions

## Measurement Considerations

1. For best results, choose a target that is flat, hard and smooth
2. Use a section of cardboard or similar material if the target size needs to be increased
3. Replace the battery if the battery icon flashes on the display
4. The meter will not measure through glass, liquid, or Styrofoam
5. Inaccurate measurements may result from any of the following:
  - Low battery
  - Measured distance exceeding specified range
  - Irregular shaped objects near the target

## Preparation for Measurements

1. Press the MEAS button  to switch the meter ON. The unit automatically switches OFF after three (3) minutes of inactivity. Press and hold the CLR button to switch the unit OFF manually.
2. Press the CLR button to cancel the last action performed or clear the last data displayed on the screen.
3. Press CLR and Measure button simultaneously while in Storage mode to clear all of the data stored in memory.
4. Press and hold the UNIT button  to change the unit of measure (ft = feet, in = inches, m = meters, and ' " (feet and inches).
5. Press Unit button quickly to turn the backlight on or off.
6. Use the reference button  to select the Top or Bottom distance reference.
  - In the Top mode (2), the displayed reading will represent the distance from the top of the meter to the target.
  - In the Bottom mode (1), the displayed reading will represent the distance from the bottom of the meter to the target. This is the default mode.
  - For measuring from a Tripod, corner or edge, refer to the Tripod and Positioning Bracket sections.

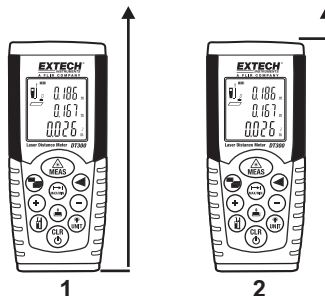

## Single Distance Measurement

1. Momentarily press the MEAS button to switch the meter ON; Dashes (- - -) will appear on the display and the Laser pointer will switch ON.
2. Aim the meter and momentarily press the MEAS button to take and display a reading. The Laser pointer switches OFF after the measurement is taken.
3. The reading will remain on the display.

## Continuous Distance Measurement

1. Press the MEAS button to switch the meter ON.
2. Press and Hold the MEAS button for 3 seconds to begin a continuous measurement session. The meter will beep and the continuous laser display icon will appear (as shown in the Display Description section of this guide).
3. Each subsequent press of the MEAS button takes a new distance measurement.
4. Switch the Continuous mode ON/OFF by pressing and holding the MEAS button for 3 seconds.

## MAX-MIN Continuous Measurement 'Tracking' Mode



This mode of operation is useful for determining the shortest and longest distances from a given point. The meter can be moved to various targets while the display updates every half second on the third display line. The MIN and MAX values are displayed dynamically on the first and second display lines.

1. Press the MEAS button to switch the meter ON.
2. Press and Hold the MAX/MIN button for 3 seconds to begin a continuous measurement session. The meter will beep, the laser pointer will stay in continuous mode, and the continuous laser display icon will appear (as shown in the Display Description section of this guide).
3. The meter will beep with each new measurement update (approx. every one half second).
4. The MIN reading will be indicated and will update each time a lower reading (lower than the currently displayed reading) is encountered.
5. The MAX reading will be indicated and will update each time a higher reading is encountered.
6. The actual reading will be indicated on the bottom display line.
7. To exit this mode of operation, momentarily press the MEAS button.
8. Note that the meter exits to the normal mode of operation after approx. 100 measurements in continuous mode.

MIN

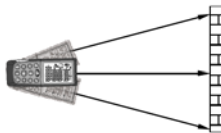

MAX

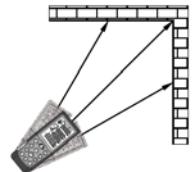



## Adding / Subtracting Measurements

The sum or difference of two measurements can be displayed.

1. Press the MEAS button to switch the meter ON.
2. Press the MEAS button to take the first reading.
3. Press the plus sign (+) or minus sign (-) button as desired. The plus or minus sign will appear flashing.
4. Press the MEAS button to take the second reading.
5. Read the sum or difference of the two readings on display line 4.
6. Press CLR to cancel the last step.
7. Press MAX/MIN to return to single distance measurement.

## Area Calculation

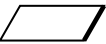

The DT500 allows the user to compute the area of a room.

1. Press the MEAS button to turn the meter ON; wait several seconds and the Laser pointer will switch ON.
2. Press the  button firmly once.
3. A parallelogram will appear with its length side flashing  indicating that a Length measurement is to be taken.
4. Aim the meter and press MEAS to take the room length measurement.
5. Press the MEAS again to switch the Laser Pointer back ON.
6. The parallelogram will now appear with its Width side flashing  indicating that a Width measurement is to be taken.
7. Press MEAS to take the room width measurement.
8. Lines 1, 2, and 4 will now show the Length, Width, and Area (in ft<sup>2</sup> or m<sup>2</sup>) respectively.

Note that the laser pointer will switch off automatically if too much time is taken between the steps above. If this occurs, simply press the MEAS button to switch the Laser pointer back ON and then continue following the steps.

## Volume Calculation

The DT500 allows the user to compute room Volume.

1. Press the MEAS button to switch the meter ON. Wait several seconds and the Laser pointer will automatically switch ON.
2. Press the  button firmly twice (allow a second or so between presses).
3. A cube shape will appear with its Length side flashing  indicating that a Length measurement is to be taken.
4. Press MEAS to take the room Length measurement.
5. The cube's Width side will now be flashing  indicating that a Width measurement is to be taken.
6. Press MEAS to switch the Laser pointer ON again.
7. Press MEAS again to take the room Width measurement.



8. The cube's Height side will now be flashing indicating that a Height measurement is to be taken.
9. Press MEAS to switch the Laser pointer ON again.
10. Press MEAS to take the room Height measurement. 
11. Lines 1, 2, and 3 will now show the Length, Width, and Height respectively. Line 4 will display the Volume in cubic feet or meters (ft<sup>3</sup> or m<sup>3</sup>).

### Indirect Measurements (Using Two Measurements)

The DT500 can measure the vertical height from Point 1 to Point 2 with the operator taking the measurement from Point X. This is accomplished using two measurements.

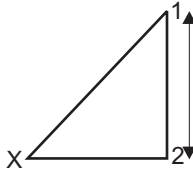



1. Press the MEAS button to switch the meter ON.
2. Press the  button once. Wait several seconds and the Laser pointer will automatically switch ON.
3. A right triangle shape will appear with its diagonal line flashing.
4. From exactly Point X, aim the instrument at Point 1 and press MEAS. One reading is now complete and the bottom line of the right triangle will begin flashing.
5. From Point X, align the meter as horizontal as possible and aim for Point 2 and then press MEAS. The laser pointer will switch ON.
6. Press MEAS again to take the second measurement.
7. The second measurement is now complete. The lower summary display line indicates the vertical distance from Point 1 to Point 2.

## Indirect Measurements (Using Three Measurements)

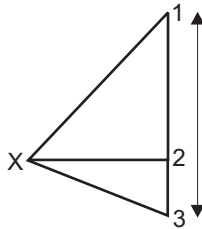

The DT500 can measure height in two segments by taking three measurements. The operator stands at Point X. The first measurement is Point X to 1, the second measurement is a horizontal line from Point X to 2, and the third measurement is from Point X to 3.



1. Press the MEAS button to switch the meter ON. Wait several seconds and the Laser pointer will switch ON.
2. Press the  button two times.
3. The double triangle icon  will appear with its bottom diagonal line flashing.
4. From Point X aim the instrument at Point 1 and press MEAS. One reading is now complete and the middle line of the double triangle will begin flashing.
5. Press MEAS again to turn on the laser pointer to prepare for the next measurement.
6. From Point X, aim the instrument horizontally at a Point 2 and press MEAS. The second reading is now complete and the top diagonal line of the double triangle will begin flashing.
7. Press MEAS to turn on the laser pointer and prepare for the third measurement.
8. From Point X, aim the instrument at Point 3 and press MEAS. The third measurement is now complete.
9. The distance from Point 1 to Point 3 will now be indicated on the bottom summary display line.

## Storing and Recalling Readings (Historical Storage)

The DT500 stores up to twenty (20) readings in memory for later recall.

1. Take a reading as previously described.
2. With the reading displayed, press the Store-Recall Memory  button.
3. The reading will be stored in location 1 and the memory location number 01 will be indicated at the top of the LCD.
4. Take another reading and press the Store-Recall Memory button. This new reading will be stored in location 1 and the previous reading from location 1 will be moved to location 2.
5. When all twenty locations have been filled the meter begins overwriting the existing readings.
6. To recall the stored readings, press the Store-Recall button. The memory location number indicated at the top of the display will increment and the display will show the stored data for the selected memory location. Note that the + and – buttons can also be used to scroll through the stored reading memory locations.
7. To clear all readings, enter the memory mode using the Store-Recall Memory button  and then press and hold both the CLR and the Memory buttons until the displayed memory location reading value switches to zero.

## Taking a measurement using a Tripod

Press and hold the reference button to switch the tripod reference On or Off.

The tripod arrow indicator will appear on the display (see #4 in Display description).

Your measurements will now be referenced to the center of the tripod mounting hole.

## Positioning Bracket – Edge and corner measurements

The unit can be adapted for multiple measuring situations.

Place the Reference to measure from the Bottom edge.

1. To measure from an edge, fold out the positioning bracket until it locks into place.  
Place the positioning bracket flat against the edge surface.

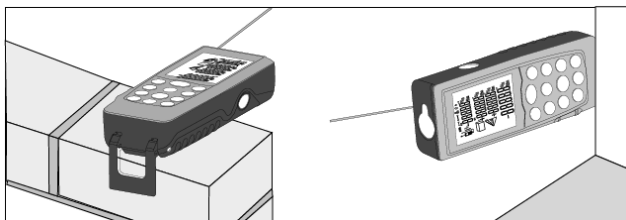

2. To measure from a corner, open the positioning bracket until it locks into place. Push the bracket to the left to fold it out fully. Place the bottom edge of the extended positioning bracket into the corner.

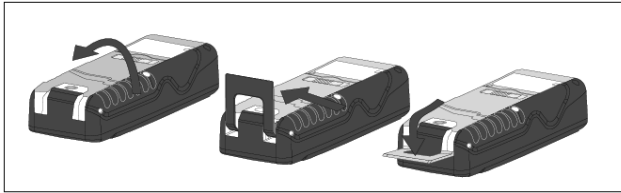

### Timer Delay (Self-Triggering)

1. Press the Timer button quickly to set a 5 second time delay.
2. To set a different time delay value, press the Timer button momentarily and then quickly press **and hold** it. The display will rapidly scroll through the timer selections (maximum of 60 seconds). The + and - buttons can also be used to change the time delay value.
3. Press MEAS button and a countdown will begin (e.g. 59, 58, 57...). The last 2 seconds will flash and beep quicker. After the last beep the measurement is taken and the value is displayed.

### Bluetooth® Communications

1. Press and hold Bluetooth/Timer button until the Bluetooth symbol is displayed.
2. Use the App (ExView DT500) installed from the Apple APP STORE on an iOS device to read the measurements.
3. While the initial connection between the iOS device or PC, and the DT500 is being established, a prompt for a pin code is displayed. Enter pin code '0000' into the iOS device or PC to view the measurements.
4. The Bluetooth switches OFF as soon as the unit is powered OFF. To turn off manually, press and hold the Bluetooth/Timer button until the Bluetooth symbol disappears.
5. The operation of this ExView DT500 software is covered in a booklet provided with the meter. The title of the manual is Meterbox iLDM User Manual.

## Tilt Measurement

1. The inclination sensor measures tilts up to  $\pm 65^\circ$ .
2. Press the Tilt/Stakeout  button once. The triangular tilt symbol will appear on the display.
3. The tilt angle value will show on line 1 of the display in degrees ( $^\circ$ ). Press the MEAS button to take the measurement and view the calculation for the inclination and the distance.  
Note that during the tilt measurement the meter face must be pointing straight up or be held within a horizontal tilt limit of  $\pm 10^\circ$ .
4. The distance 'L' is displayed in the summary display line 4. The distance of lines **a** and **b** are calculated by  $\alpha$  and **L** and are displayed in lines 2 and 3 respectively.

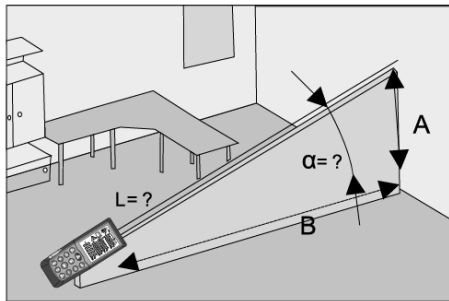

## Stake-out Function

The stake-out function allows you to setup two separate distances (see **a** and **b** in diagram) that can be used independently to mark defined measured lengths (for example in wood frame construction).

1. Press the MEAS button to switch the meter ON.  
Set the measurement reference to front or rear
2. Press and hold the Tilt/Stakeout  button until the meter beeps and the stakeout symbol appears in the display as shown in the display description section of this guide.
3. The value for "a" will flash. Use the + and – buttons, set the value of your "a" stakeout distance.
4. Once the desired value has been obtained press the Memory Store-Recall button to save the value.
5. The "b" value will now flash. Use the + and – buttons, set the value of your "b" stake out distance.
6. Once the desired value has been obtained press the Memory Store-Recall button to save the "b" value.
7. Press the Memory Store-recall button to toggle from "a" or "b" to select what dimension you want to use.
8. Place the meter in position and Press the MEAS button to start the laser measurement. The display will show the current measuring distance in the summary line. When the meter is moved slowly along the stakeout line the displayed distance will decrease or increase. The arrows in the display indicate which direction the meter needs to be moved to match the distance programmed (a or b). Also line 4 will display a + or – sign indicating which way to move the meter to match the programmed distance.
9. The meter will beep more rapidly at a distance of 0.1m from the matching dimension.
10. As soon as the stakeout point is reached the beep changes and the intermediate line begins flashing. You can now mark your location.
11. Exit the function by pressing MEAS and CLR buttons simultaneously.

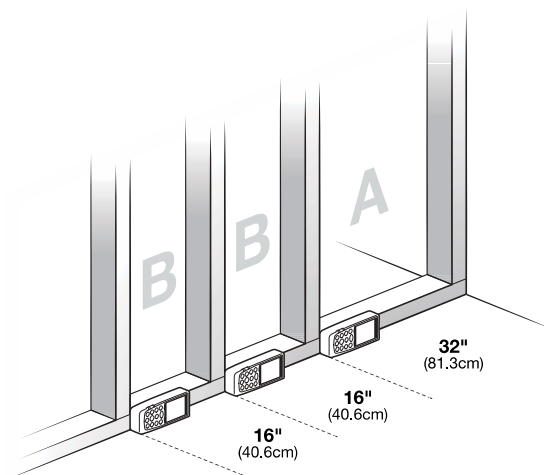

## Maintenance

**WARNING:** Do not operate the meter until the battery compartment cover is in place and fastened securely.

This instrument is designed to provide years of dependable service, if the following care instructions are performed:

1. **Keep the meter dry and free from dust.**
2. **Use and store the meter in nominal temperature conditions.** Temperature extremes can shorten the life of the electronic parts and distort or melt plastic parts.
3. **Handle the meter carefully and avoid shock and vibration.** Dropping the meter may damage the electronic parts or the case.
4. **Keep the meter clean.** Wipe the case occasionally with a damp cloth. DO NOT use chemicals, cleaning solvents, or detergents.
5. **Use only fresh batteries of the correct type.** Remove old or weak batteries so they do not leak and damage the unit.
6. **If the meter is to be stored for long periods,** the batteries should be stored separately to prevent damage to the unit.

## Battery Installation/Replacement

When the low battery symbol appears on the display or when the display does not switch ON, replace the two (2) 'AA' batteries.

1. Switch the instrument off before replacing the batteries.
2. Pull the end-piece out (away) from the body of the meter so that the battery compartment cover has room to open.
3. Slide the rear battery compartment lever to the right and then pull open the battery compartment.
4. Replace the two (2) 'AA' batteries observing polarity.
5. Replace the battery compartment cover.

### Battery Safety Reminders

Never dispose of batteries in a fire. Batteries may explode or leak.

Never mix battery types. Always install new batteries of the same type.



Never dispose of used batteries or rechargeable batteries in household waste.

As consumers, users are legally required to take used batteries to appropriate collection sites, the retail store where the batteries were purchased, or wherever batteries are sold.

**Disposal:** Do not dispose of this instrument in household waste. The user is obligated to take end-of-life devices to a designated collection point for the disposal of electrical and electronic equipment.

## Other Considerations

### Range considerations

The range is limited to 70m (230'). At night or dusk if the target is in shadow the measuring range without target plate is increased. Use a target plate to increase the measurement range during daylight or if the target has poor reflection properties. In unfavorable conditions such as intense sunlight, poor reflective surfaces, or high temperatures distances over 10m (33ft.) can increase by  $\pm 0.15\text{mm/m}$  ( $\pm 0.0018\text{in/ft.}$ )

### Target surfaces

Measurement errors can occur when measuring toward colorless liquids (e.g. water), dust free glass, Styrofoam or similar semi-permeable surfaces. Aiming at high gloss surfaces may deflect the laser beam and lead to measurement errors. Against non-reflective and dark surfaces the measuring time may increase.

### Care

Do not immerse the instrument in water. Wipe off dirt with a damp, soft cloth. Do not use aggressive cleaning agents, solvents, abrasives, or such solutions. Handle the instrument as you would a telescope or camera.

## Display Error Codes

For any error codes, cycle power to the instrument to see if the error clears. If the error persists after several power cycles, following the directives below. Note that a 'wrench' icon appears with error code displays.

**204** – Calculation Error (retry the procedure)

**208** – Received signal too weak. Measurement time is too long. Distance >50m (Use target plate)

**209** – Received signal too strong (Target too reflective, use a target plate)

**252** – High Temperature (Cool down the instrument)

**253** – Low Temperature (Warm up the instrument)

**255** – Hardware error (Return the instrument for service)



# Specifications

---

## General Specifications

Laser diode	Class 2 red laser (wavelength: 635nm)
Battery	Two (2) 'AA' alkaline batteries
Battery Life	Up to 8,000 measurements
Auto Laser Switch-off	After 30 seconds
Auto Instrument Switch-off	After 3 minutes
Dust/Splash Proof	IP 54
Operating conditions	0 to 40°C (32 to 104°F)
Storage conditions	-10 to 60°C (14 to 140°F)
Dimensions	135 x 53 x 30mm (5.3 x 2.1 x 1.2")
Weight	160g (5.6 oz.)
Recommended use	indoor use only

## Range Specifications

Distance Range	0.05 to 70m (2" to 230'); Use a target plate >50m (164')
Resolution	0.001 inches, feet, or meters
Accuracy (up to 10m)	±1.5mm (± 0.06")
Range of Bluetooth	10m (32.8')

## Displayed Calculation Ranges

Length	99.99m (99' 11")
Area	999.99m <sup>2</sup> (999.99 sq. ft)
Volume	999.99m <sup>3</sup> (999.99 cu. ft)

**Copyright © 2014-2016 FLIR Systems, Inc.**

All rights reserved including the right of reproduction in whole or in part in any form

**ISO-9001 Certified**